

**SLIDING
PATIO DOOR**

ALL PVC
WITH WELDED SASH



**DESIGNED TO WORK
LIKE A CHARM**



THE QUIETEST,
MOST THERMALLY
EFFICIENT DOOR
AVAILABLE ON
THE MARKET TODAY.

UNPRECEDENTED ENERGY EFFICIENCY!



- Performance that meets the highest standards in terms of energy efficiency and meets the latest Canadian and American energy standards.
- Design that allows for optional 1"-thick triple-glazed sealed units, with or without integrated aluminum blinds.
- Efficient division between the glass and steel reinforcement, reducing significantly the risks of condensation.

CLEARLY THE HIGHEST VALUE FOR YOUR MONEY.

STANDARD FEATURES

DESIGNED TO WORK LIKE A CHARM—WITH P.H. TECH PERFORMANCE THAT'S BUILT TO LAST

✓ SMOOTH AND QUIET

These doors slide open smoothly and quietly thanks to:

- Patented dual-tandem nylon wheels
- A raised rail to protect the wheels from dirt and debris

Sturdy all-aluminum angle-legged tracks



Competition

P.H. Tech

- Perfectly straight and carefully adjusted parts to minimize friction and make for smoother operation

✓ MULTICHAMBER DESIGN

Our multichamber design reduces thermal exchange and, with more enclosed air space than other brands, increases insulation values—without the addition of costly, less recyclable insulating material.

✓ THE SOUND OF SILENCE

Shhhh... Enjoy the sound of silence! Multichamber profiles and multiple weatherstripping help eliminate most outside noise.

INCREASED PROTECTION

Fixed and mobile panel rails meet and interlock perfectly, making removal from outside almost impossible. Lower sill design provides safer entry and exit.



OUTSTANDING RELIABILITY

Engineered to perform at PG60 levels at all sizes up to 70-7/8" x 81-7/8", this door provides reliability that will stand the test of time, and is particularly watertight.

How do we measure carefree operation? How about more than 1 million P.H. Tech doors sold—and one of the lowest service rates in the industry!

Try the P.H. Tech fingertip test: bet you can open this door with just the tip of a finger! The easiest door to operate in its category.

INSTALLER-FRIENDLY DESIGN

Installer-friendly design and room for panel adjustment mean uneven surfaces are never a problem—it's a snap to plumb and square P.H. Tech doors.

OPERATING FORCE TEST

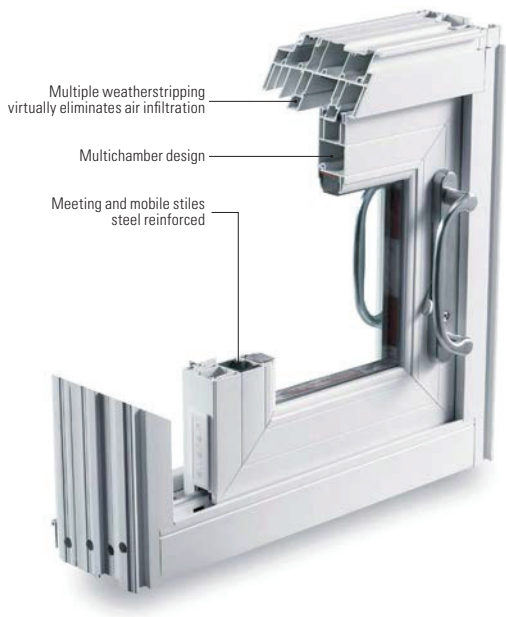
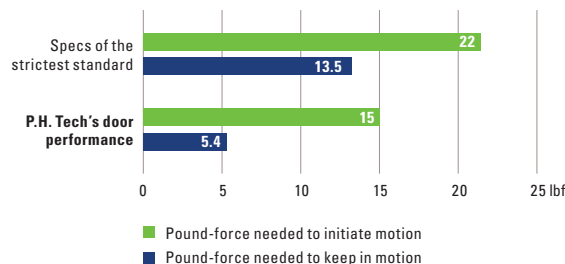

CONSERVATION

We're into Conservaction®!

Our patio doors not only offer unique and distinctive technical features—they're also all specially designed to save energy and preserve natural resources. Longer product life, and the best energy performance in the industry!

HAVE IT YOUR WAY!

CUSTOMIZATION

MULTIPLE CONFIGURATIONS

This patio door series is available in 2-panel, 3-panel and 4-panel configurations, with a wide range of energy-smart glazing options and decorative grilles.

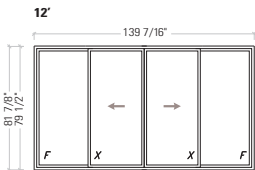
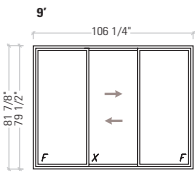
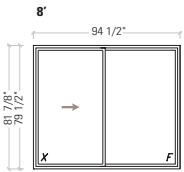
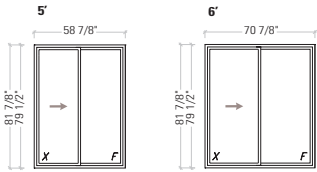

CHOICE OF COLORS

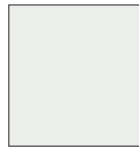

White

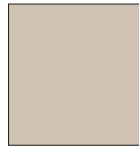

Beige

CHOICE OF SCREENS

It's smooth sliding all the way with those patio door screens. Our extruded aluminum screens, equipped with patented spring-loaded rollers, are fully adjustable at each corner, to prevent bothersome derailing.

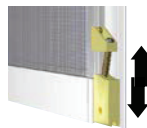

Patented spring-loaded rollers

CHOICE OF HANDLES

All locking mechanisms are encased in galvanized steel reinforcement. Round-shaped metal handles are offered with interior/exterior grip.



Black nickel



Wood



Black



White



Brushed chrome
(Also available in bright chrome)



Brass

MULTIPOINT LOCKING SYSTEM

A multipoint locking system (optional) provides optimum resistance and security to forced entry.



PANORAMIC MULLING

This patio door perfectly complements our high-end window profiles for a spectacular look.



SYSTEM WARRANTY

P.H. Tech Inc. provides a 20-year limited warranty on all residential PVC profiles. Manufacturer's warranty may offer coverage that is different than P.H. Tech's.

S-7500 All-PVC sliding door

Size tested (in.)	Harmonized Standard AAMA/WDMA/CSA 101/1.S.D/AA440-08
70 7/8 x 81 7/8	R-PG60-SD
96 x 96	LC-PG35-SD

P.H. Tech is a trademark licensed to P.H. Tech Inc. P.H. Tech Inc. manufactures PVC extrusions, and window and door profiles. Windows and doors are produced, assembled, installed and distributed by authorized independent manufacturers and retailers. All efforts have been made to ensure that the information in this publication is accurate. However, P.H. Tech Inc. will accept no liability for any errors or omissions herein and reserves the right to discontinue, replace or alter product lines and product features without any obligation whatsoever.